PRODUCT SPECIFICATIONS

For Customer: _____ : APPROVAL FOR SPECIFICATION

Customer Model No. _____ : APPROVAL FOR SAMPLE

Module No.: HT070JGI50-07376L

Date : 2019.03.13

Version :A

1. Table of Contents

No.	Item	Page
1	Cover Sheet(Table of Contents)	
2	Revision Record	
3	General Specifications	
4	Outline Drawing	
5	Absolute Maximum Ratings	
6	Electrical Specifications and Timing Characteristics	
7	Optical Characteristics	
8	Reliability Test Items and Criteria	
9	Quality Level	
10	Packing Reliability	

For Customer's Acceptance:

Approved By	Comment

PREPARED	CHECKED	VERIFIED BY QA DEPT	VERIFIED BY R&D DEPT

2. Revision Record

Date	Rev.No.	Page	Revision Items	Prepared
2019.03.13	A		The first release	

3. General Specifications

HT070JGI50-07376L is a TFT-LCD module. It is composed of a TFT-LCD panel, driver IC, FPC, a back light unit. The 7.0 ''display area contains 1024 x 600 pixels and can display up to 16.7M colors. This product accords with RoHS environmental criterion.

Item	Contents	Unit	Note
LCD Type	Normally Black, Transmissive	-	
Display color	16.7M		1
Viewing Direction	ALL	O'Clock	
Operating temperature	-20~+70	°C	
Storage temperature	-30~+80	°C	
Module size	165.00(W)×100.00(H)×3.50(T)	mm	2
Active Area(W×H)	154.2144(W)×85.92(H)	mm	
Number of Dots	1024×RGB×600	dots	
Backlight	27-LEDs (white)	pcs	
Interface	RGB Interface	-	
Driver IC	HX8282-A11+HX8696-A		

Note 1: Color tune is slightly changed by temperature and driving voltage.

Note 2: Without FPC and Solder.

5. Absolute Maximum Ratings(Ta=25°C)

5.1 Electrical Absolute Maximum Ratings.(V_{SS}=0V ,Ta=25°C)

Item	Symbol	Min.	Max.	Unit
Digital Supply Voltage	VDD	-0.3	3.6	V
Analog Supply Voltage	AVDD	-0.5	14.85	V
TFT Gate ON Voltage	VGH	0.3	20	V
TFT Gate OFF Voltage	VGL	-20	0.3	V
TFT Common Electrode Voltage	VCOM	0	6	V
Operating Temperature	TOP	-20	70	°C
Storage Temperature	TST	-30	80	°C

Notes:

1. If the module is above these absolute maximum ratings. It may become permanently damaged.
Using the module within the following electrical characteristic conditions are also exceeded, the module will malfunction and cause poor reliability.
2. VDD>V_{SS} must be maintained.
3. Please be sure users are grounded when handing LCD Module.

5.2 Environmental Absolute Maximum Ratings.

Item	Storage		Operating		Note
	MIN.	MAX.	MIN.	MAX.	
Ambient Temperature	-30°C	80°C	-20°C	70°C	1,2
Humidity	-	-	-	-	3

1. The response time will become lower when operated at low temperature.
2. Background color changes slightly depending on ambient temperature.
The phenomenon is reversible.
3. Ta<=40°C:85%RH MAX.

Ta>=40°C:Absolute humidity must be lower than the humidity of 85%RH at 40°C.

6. Electrical Specifications and Timing Characteristics

6.1 Electrical characteristics($V_{SS}=0V$, $T_a=25^{\circ}C$)

Item	Symbol	Min.	Typ	Max.	Unit
Digital Supply Voltage	VDD	3.0	3.3	3.6	V
Analog Supply Voltage	AVDD	9.4	9.6	9.8	V
TFT Gate ON Voltage	VGH	17.0	18.0	19.0	V
TFT Gate OFF Voltage	VGL	-6.6	-6.0	-5.4	V
TFT Common Electrode Voltage	VCOM	-	-	-	V

6.2 LED backlight specification($V_{SS}=0V$, $T_a=25^{\circ}C$)

Item	Symbol	Condition	Min	Typ	Max	Unit	Note
Supply voltage	-	-	9.0	9.6	10.8	V	1
Supply current	I_f	-	-	180	-	mA	2

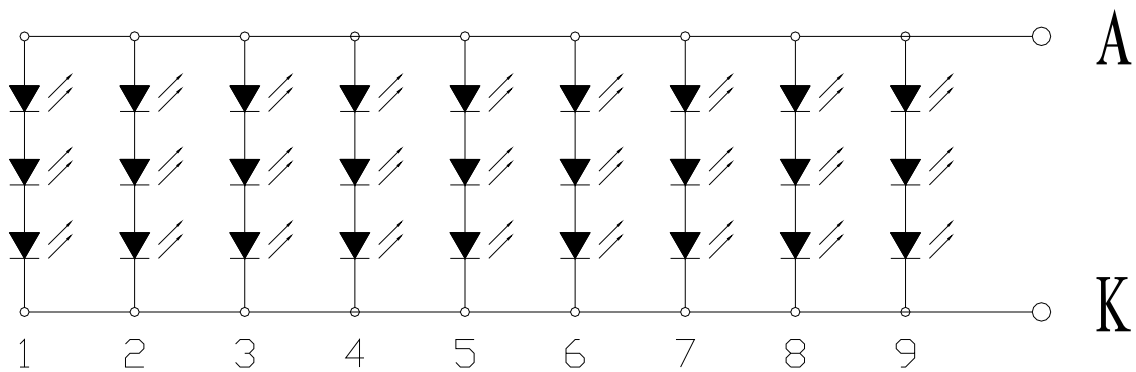

Note:

1: $V_{LED} = V_{LED(+)} - V_{LED(-)}$.

2: The current of LED is 20mA.

A LED drive in constant current mode is recommended.

6.3 Interface signals

Pin NO.	SYMBOL	I/O	DESCRIPTION	Remark
1	VLED+	P	Power for LED backlight (Anode)	Note 8
2	VLED+	P	Power for LED backlight (Anode)	Note 8
3	VLED-	P	Power for LED backlight (Cathode)	Note 8
4	VLED-	P	Power for LED backlight (Cathode)	Note 8
5	GND	P	Power ground	
6	VCOM	I	Common Voltage	
7	DVDD	P	Digital Power	
8	MODE	I	DE/SYNC mode select.	Note 1
9	DE	I	Data Enable signal	
10	VSYNC	I	Vertical sync input	
11	HSYNC	I	Horizontal sync input	
12	B7	I	Blue data (MSB)	
13	B6	I	Blue data	
14	B5	I	Blue data	
15	B4	I	Blue data	
16	B3	I	Blue data	
17	B2	I	Blue data	
18	B1	I	Blue data	Note 2
19	B0	I	Blue data (LSB)	Note 2
20	G7	I	Green data (MSB)	
21	G6	I	Green data	
22	G5	I	Green data	
23	G4	I	Green data	
24	G3	I	Green data	
25	G2	I	Green data	
26	G1	I	Green data	Note 2
27	G0	I	Green data (LSB)	Note 2

28	R7	I	Red data (MSB)	
29	R6	I	Red data	
30	R5	I	Red data	
31	R4	I	Red data	
32	R3	I	Red data	
33	R2	I	Red data	
34	R1	I	Red data	Note 2
35	R0	I	Red data (LSB)	Note 2
36	GND	P	Power ground	
37	DCLK	I	Clock input	Note 3
38	GND	P	Power ground	
39	SHLR	I	Left / Right Selection	Note 4,5
40	UPDN	I	Up / Down Selection	Note 4,5
41	VGH	P	Gate ON Voltage	
42	VGL	P	Gate OFF Voltage	
43	AVDD	P	Power for Analog Circuit	
44	RESET	I	Global reset pin	Note 6
45	NC	-	Not connection	
46	VCOM	I	Common Voltage	
47	DITH	I	Dithering function enable control	Note 7
48	GND	P	Power ground	
49	NC	-	Not connection	
50	NC	-	Not connection	

I: input, O: output, P: Power

Note 1: DE / SYNC mode select. Normally pull high.

When MODE=H, DE mode.

When MODE=L, SYNC mode.

Note 2: When input 18 bits RGB data, the two low bits of R, G and B data must be grounded

Note 2: Data shall be latched at the falling edge of DCLK.

Note 4: Selection of scanning mode

Setting of scan control input		Scanning direction
U/D	L/R	
GND	DV _{DD}	Up to down, left to right
DV _{DD}	GND	Down to up, right to left
GND	GND	Up to down, right to left
DV _{DD}	DV _{DD}	Down to up, left to right

Note 5: Definition of scanning direction.
Refer to the figure as below:

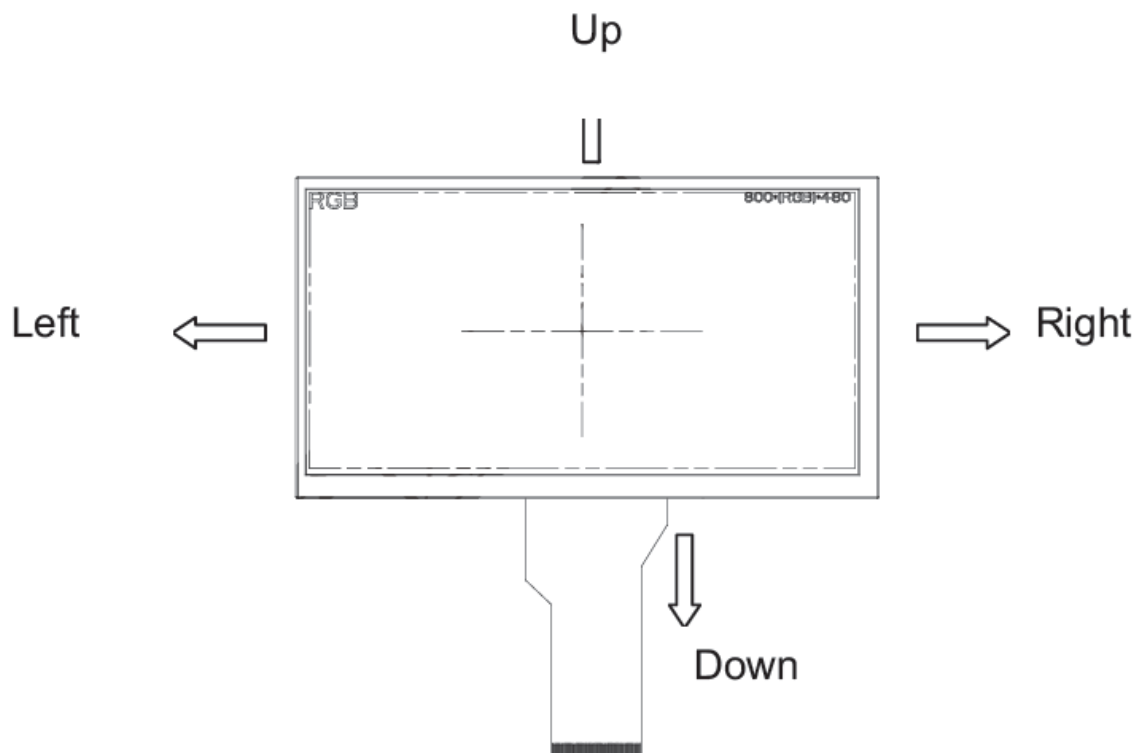

Note 6: Global reset pin. Active low to enter reset state. Suggest to connect with an RC reset circuit for stability. Normally pull high.

Note 7: Dithering function enable control. Normally pull low
 DITHER = "1", Enable internal dithering function
 DITHER = "0", Disable internal dithering function

Note 8: Reserve for LED power input.

7. Optical Characteristics

Item	Symbol	Condition	Min.	Typ.	Max.	Unit	Note
Brightness	Bp	$\theta=0^\circ$	-	500	-	Cd/m ²	1
Uniformity	Δ Bp	$\Phi=0^\circ$	75	80	-	%	1,2
Viewing Angle	3:00	Cr \geq 10	80	85	-	Deg	3
	6:00		80	85	-		
	9:00		80	85	-		
	12:00		80	85	-		
Contrast Ratio	Cr	$\theta=0^\circ$ $\Phi=0^\circ$	500	800		-	4
Response Time	T _r +T _f			25	40	ms	5
Color of CIE Coordinate	W	x	TYP -0.05	0.303	TYP +0.05	-	1,6
		y		0.333		-	
	R	x		-		-	
		y		-		-	
	G	x		-		-	
		y		-		-	
	B	x		-		-	
		y		-		-	

Note: The parameter is slightly changed by temperature, driving voltage and material

Note 1: The data are measured after LEDs are turned on for 5 minutes. LCM displays full white.

The brightness is the average value of 9 measured spots. Measurement equipment PR-705 (Φ 8mm)

Measuring condition:

- Measuring surroundings: Dark room.
- Measuring temperature: Ta=25°C.
- Adjust operating voltage to get optimum contrast at the center of the display.

Measured value at the center point of LCD panel after more than 5 minutes while backlight turning on.

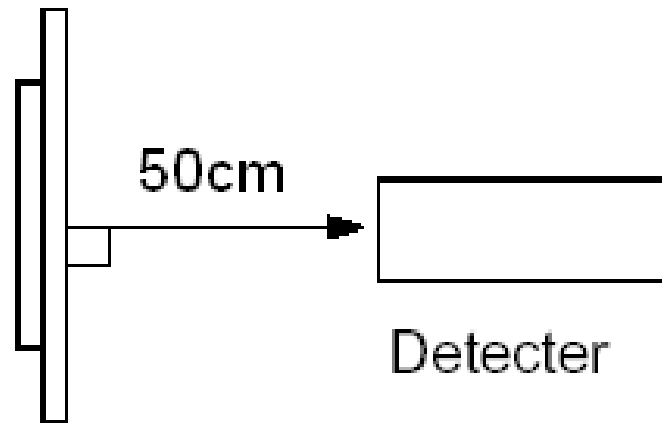

Note 2: The luminance uniformity is calculated by using following formula.

$$\Delta B_p = B_p (\text{Min.}) / B_p (\text{Max.}) \times 100 (\%)$$

$B_p (\text{Max.})$ = Maximum brightness in 9 measured spots

$B_p (\text{Min.})$ = Minimum brightness in 9 measured spots.

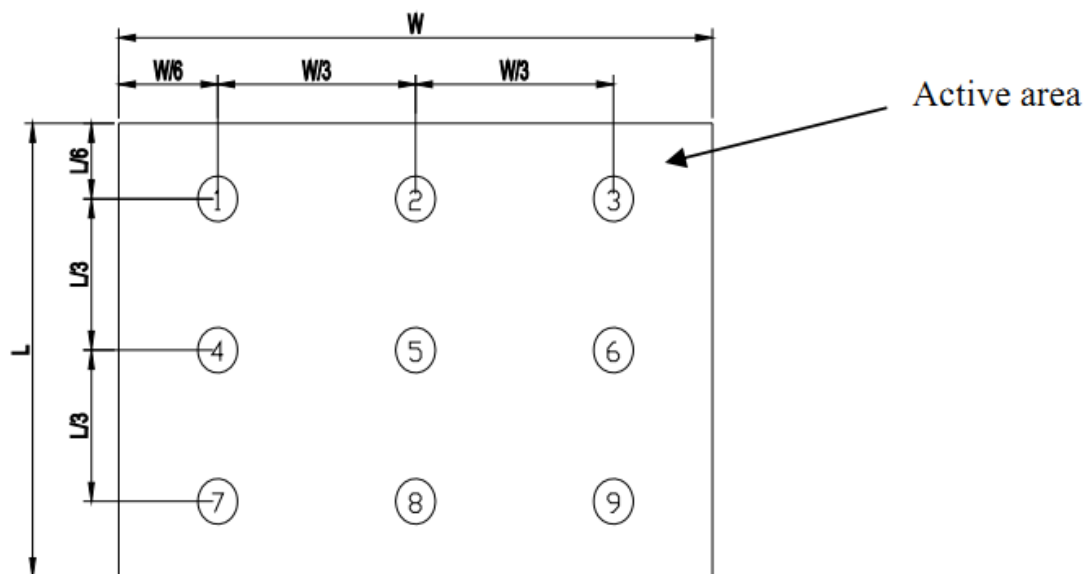

Note 3: The definition of viewing angle:

Refer to the graph below marked by θ and ϕ

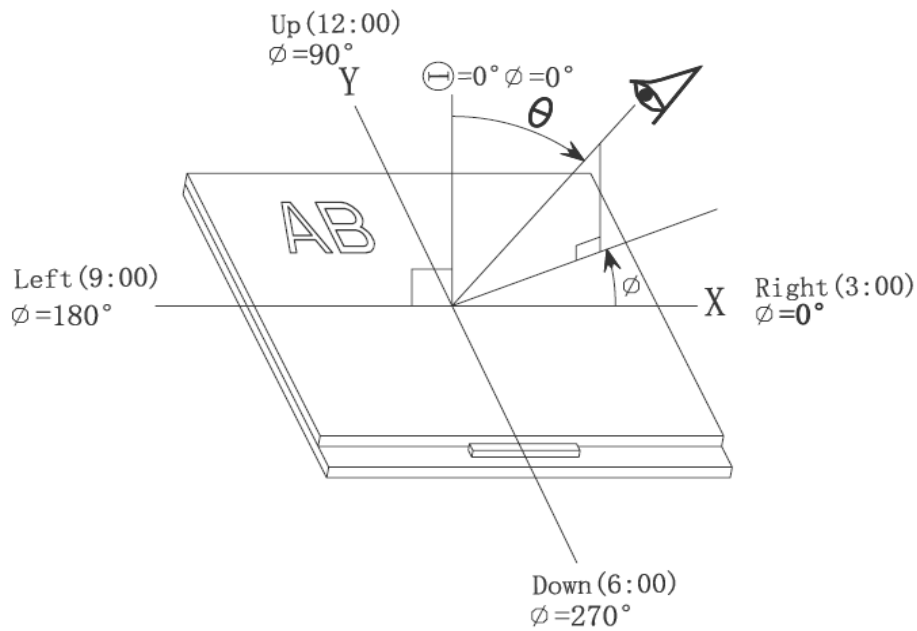

Note 4: Definition of contrast ratio.(Test LCD using DMS501)

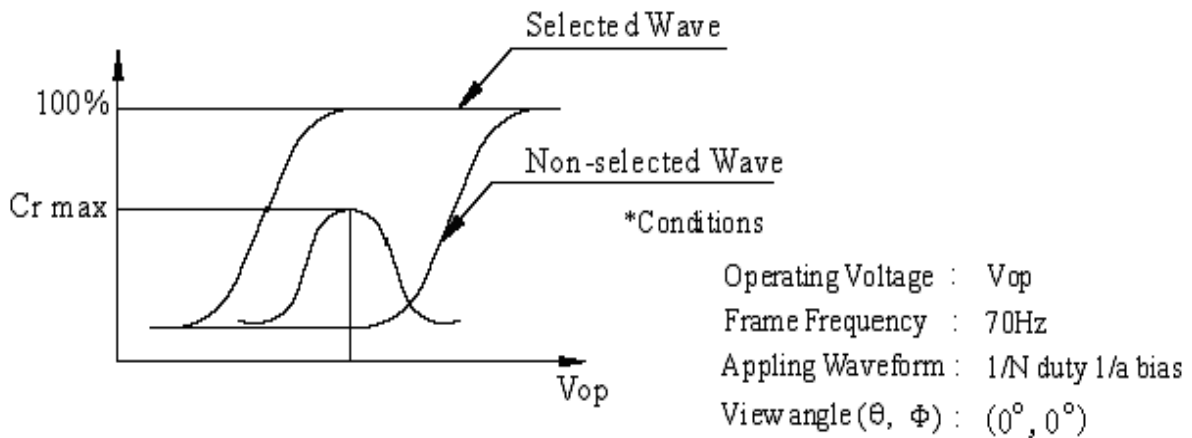

$$\text{Contrast ratio}(Cr) = \frac{\text{Brightness of selected dots}}{\text{Brightness of non-selected dots}}$$

Note 5: Definition of Response time. (Test LCD using DMS501):

The output signals of photo detector are measured when the input signals are changed from “black” to “white”(falling time) and from “white” to “black”(rising time), respectively. The response time is defined as the time interval between the 10% and 90% of amplitudes.Refer to figure as below.

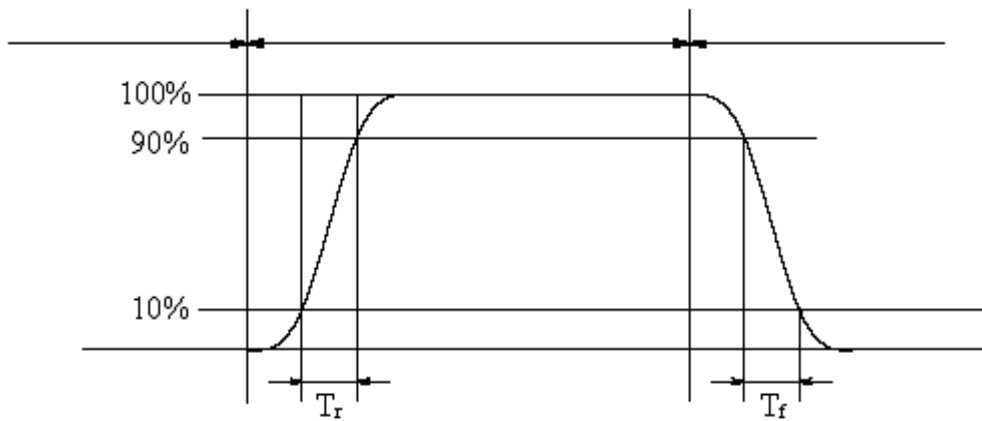

The definition of response time

Note 6: Definition of Color of CIE Coordinate and NTSC Ratio.

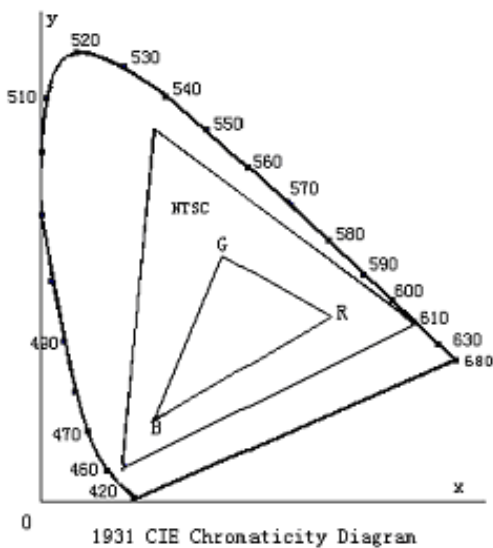

Color gamut:

$$S = \frac{\text{area of RGB triangle}}{\text{area of NTSC triangle}} \times 100\%$$

Note 7: Definition of cross talk.

$$\text{Cross talk ratio(\%)} = \frac{|\text{pattern A Brightness} - \text{pattern B Brightness}|}{\text{pattern A Brightness}} \times 100$$

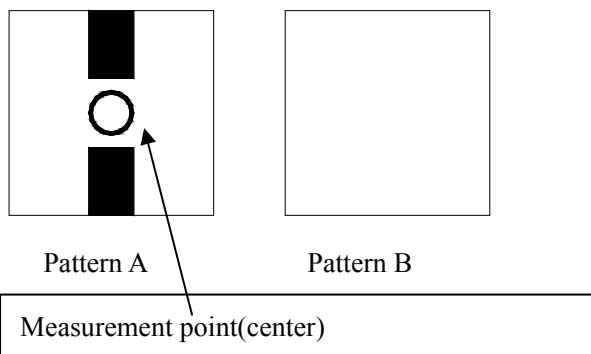

Electric volume value=3F+/-3Hex

8. Reliability Test Items and Criteria

No	Test Item	Test condition	Criterion
1	High Temperature Storage	80°C±2°C 96H Restore 2H at 25°C Power off	1. After testing, cosmetic and electrical defects should not happen. 2. Total current consumption should not be more than twice of initial value.
2	Low Temperature Storage	-30°C±2°C 96H Restore 2H at 25°C Power off	
3	High Temperature Operation	70°C±2°C 96H Restore 2H at 25°C Power on	
4	Low Temperature Operation	-20°C±2°C 96H Restore 4H at 25°C Power on	
5	High Temperature/Humidity Operation	50°C±2°C 90%RH 96H Power on	
6	Temperature Cycle(Storage)	-20°C←-25°C-----→70°C 30min 5min 30min after 5 cycle, Restore 2H at 25°C Power off	
7	Vibration Test	10Hz~150Hz, 100m/s ² , 120min	Not allowed cosmetic and electrical defects.
8	Shock Test	Half- sine wave,300m/s ² ,11ms	
9	ESD Test	Air discharge:+/-8KV, Contact discharge:4KV	

Note: Operation: Supply 3.3V for logic system.

The inspection terms after reliability test, as below

ITEM	Inspection
Contrast	CR>50%
IDD	IDD<200%
Brightness	Brightness>60%
Color Tone	Color Tone+/-0,05

9 Quality level

9.1 Classification of defects

Major defects (MA): A major defect refers to a defect that may substantially

degrade usability for product applications, including all functional defects(such as no display, abnormal display, open or missing segment, short circuit, missing component), outline dimension beyond the drawing, progressive defects and those affecting reliability.

Minor defects (MI): A minor defect refers to a defect which is not considered to be able to substantially degrade the product application or a defect that deviates from existing standards almost unrelated to the effective use of the product or its operation, such as black spot, white spot, bright spot, pinhole, black line, white line, contrast variation, glass defect, polarizer defect, etc.

9.2 Definition of inspection range

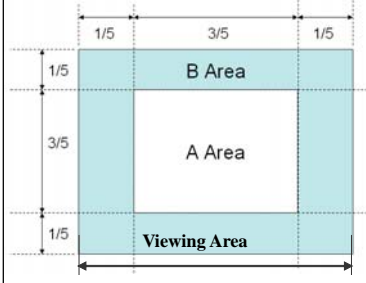
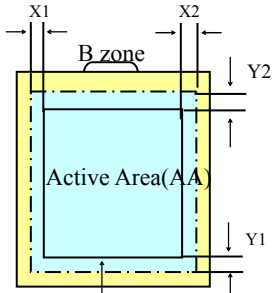
<p>For dot defect of TFT LCD which is not smaller than 3 inches, dividing three areas to make a judgment (according to figure 1).</p> <p>A area : center of viewing area B area : periphery of viewing area C area : Outside viewing area</p> <p>For other defects, dividing two areas to make a judgment (according figure 2).</p> <p>A zone : Inside Viewing area B zone : Outside Viewing area</p> <p>X1(A.A~V.A): 2mm X2(A.A~V.A): 2mm Y1(A.A~V.A): 2mm Y2(A.A~V.A): 2mm</p>	 <p>Figure 1</p>  <p>Figure 2</p>
--	---

9.3 Inspection items and general notes

<p>General notes</p>	<p>1.Should any defects which are not specified in this standard happen, additional standard shall be determined by mutual agreement between customer and SH.</p> <p>2.Viewing area should be the area which SH guarantees.</p> <p>3.Limit sample should be prior to this Inspection standard.</p> <p>4.Viewing judgment should be under static pattern.</p> <p>5.Inspection conditions Inspection distance: 250 mm (from the sample) Temperature : 25±5 °C Inspection angle : 45 degrees in 6 o'clock direction (all defects in viewing area should be inspected from this direction)</p>	
<p>Inspection items</p>	<p>Pinhole, Bright spot, Black spot, White spot, Black line, White Line, Foreign particle, Bubble</p>	<p>The color of a small area is different from the remainder. The phenomenon doesn't change with voltage</p>
	<p>Contrast variation</p>	<p>The color of a small area is different from the remainder. The phenomenon changes with voltage</p>
	<p>Polarizer defect</p>	<p>Scratch, Dirt, Particle, Bubble on polarizer or between polarizer and glass</p>
	<p>Dot defect (TFT LCD)</p>	<p>The pixel appears bright or dark abnormally when display</p>
	<p>Functional defect</p>	<p>No display, Abnormal display, Open or missing segment, Short circuit, False viewing direction</p>

	Glass defect	Glass crack, Shaved corner of glass, Surplus glass
	PCB defect	Components assembly defect

9.4 Outgoing Inspection level

Outgoing Inspection standard	Inspection conditions	Inspection				
		Min.	Max.	Unit	IL	AQL
Major Defects	See 8.3 general notes	See 8.5			II	0.065
Minor Defects	See 8.3 general notes	See 8.5			II	0.065

Note: Sampling standard conforms to GB2828

9.5 Inspection Items and Criteria

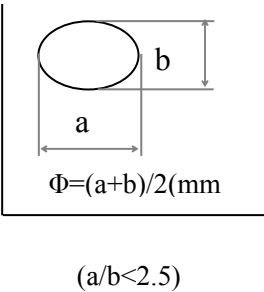
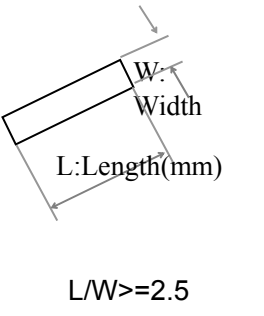
Inspection items			Judgment standard			
			Category		Acceptable number	
					A zone	B zone
1	Black spot, White spot, Pinhole, Foreign Particle, Particle in or on glass, Scratch on glass 	A	$\Phi \leq 0.20$		Neglected	Neglected
		B	$0.20 < \Phi \leq 0.25$		3	Neglected
		C	$0.25 < \Phi \leq 0.3$		2	Neglected
		D	$0.3 < \Phi \leq 0.4$		1	3
		E	$0.4 < \Phi \leq 0.5$		0	2
		Total defective point(B,C)		1	-	
		2	Black line, White line, and Particle Between Polarizer and glass, Scratch on glass 	A	$W \leq 0.03$	
B	$0.03 < W \leq 0.05$ $L \leq 3.0$			3	Neglected	
C	$0.05 < W \leq 0.1$ $L \leq 3.0$			2	Neglected	
D	$0.05 < W \leq 0.1$ $L \leq 4.0$			1	3	
E	$W > 0.1$ $L > 4.0$			0	2	
Total defective point(B,C)				1	-	

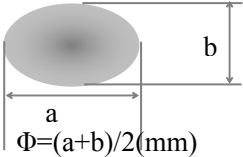
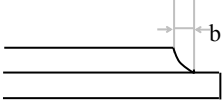
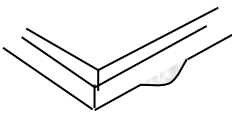
3	Bright spot		any size	none	none	
4	Contrast variation		A	$\Phi < 0.2$	Neglected	Neglected
			B	$0.2 < \Phi \leq 0.3$	2	
			C	$0.3 < \Phi \leq 0.4$	1	
			D	$0.4 < \Phi$	0	
			Total defective point(B,C)			3
5	Bubble inside cell		any size	none	none	
6	Polarizer defect (if Polarizer is used)	Scratch ,damage on polarizer, Particle on polarizer or between polarizer and glass.	Refer to item 1 and item 2.			
		Bubble, dent and convex	A	$\Phi \leq 0.1$	Neglected	Neglected
			B	$0.1 < \Phi \leq 0.2$	2	Neglected
			C	$0.2 < \Phi \leq 0.3$	1	2
7	Surplus glass	Stage surplus glass	 $B \leq 0.3\text{mm}$			
		Surrounding surplus glass	 Should not influence outline dimension and assembling.			
8	Open segment or open common		Not permitted			
9	Short circuit		Not permitted			
10	False viewing direction		Not permitted			
11	Contrast ratio uneven		According to the limit specimen			
12	Crosstalk		According to the limit specimen			
13	Black /White spot(display)		Refer to item 1			
14	Black /White line(display)		Refer to item 2			

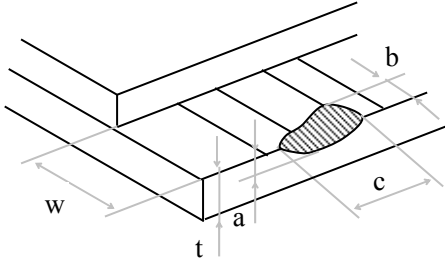
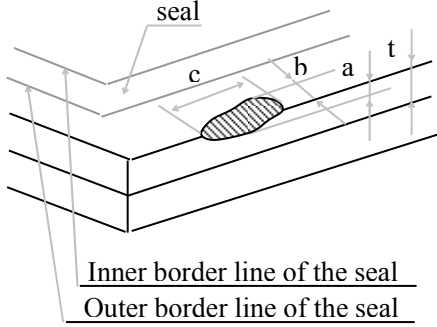
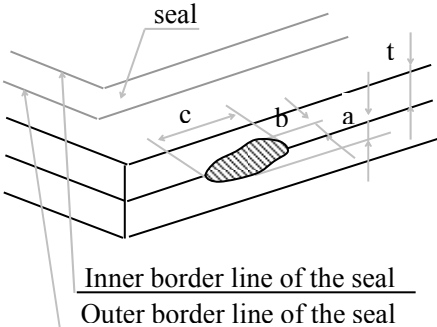
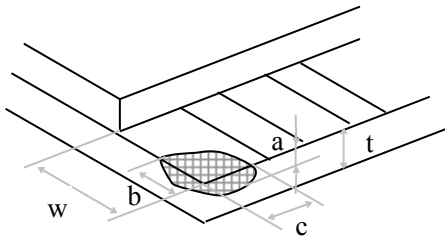
Inspection items		Judgment standard		Acceptable number	
		Category(application: B zone)			
15	Glass defect crack	i) The front of lead terminals 	A	$a \leq t, b \leq 1/5W, c \leq 3\text{mm}$	Max.3 defects allowed
			B	Crack at two sides of lead terminals should not cover patterns and alignment mark	
		ii) Surrounding crack-non-contact side 		$b < \text{Inner border line of the seal}$	
		iii) Surrounding crack- contact side 		$b < \text{Outer border line of the seal}$	
	iv) Corner 	A	$a \leq t, b \leq 3.0, c \leq 3.0$		
		B	Glass crack should not cover patterns u and alignment mark and patterns.		

Inspection items		Judgment standard	
		Category(application: B zone)	
16	PCB defect	<p>Component soldering: No cold soldering、short、open circuit、burr、tin ball The flat encapsulation component position deviation must be less than 1/3 width of the pin (Pic.1); the sheet component deviation: Pin deviates from the pad and contact with the near components is not permitted (Pic.2)</p>	
		<p>lead defect: The lead lack must be less than 1/3 of its width; The lead burr must be less than 1/3 of the seam; Impurities connect with the near leads is not permitted</p>	
		<p>Connector soldering: Soldering tin is at contact position of the plug and socket is not permitted No foundation is scald Serious cave distortion on plug and socket contact pin is not permitted</p>	
	<p>Glue on root of the speaker receiver and motor lead: The insulative coat of the lead must join into the PCB; the protected glue must envelop to the insulative coat.</p>		

10. Precautions for Use of LCD Modules

10.1 Handling Precautions

10.1.1 The display panel is made of glass. Do not subject it to a mechanical shock by dropping it from a high place, etc.

10.1.2 If the display panel is damaged and the liquid crystal substance inside it leaks out, be sure not to get any in your mouth, if the substance comes into contact with your skin or clothes, promptly wash it off using soap and water.

10.1.3 Do not apply excessive force to the display surface or the adjoining areas since this may cause the color tone to vary.

10.1.4 The polarizer covering the display surface of the LCD module is soft and easily scratched. Handle this polarizer carefully.

10.1.5 If the display surface is contaminated, breathe on the surface and gently wipe it with a soft dry cloth. If still not completely clear, moisten cloth with one of the following solvents:

- Isopropyl alcohol
- Ethyl alcohol

Solvents other than those mentioned above may damage the polarizer.

Especially, do not use the following:

- Water
- Ketone
- Aromatic solvents

10.1.6 Do not attempt to disassemble the LCD Module.

10.1.7 If the logic circuit power is off, do not apply the input signals.

10.1.8 To prevent destruction of the elements by static electricity, be careful to maintain an optimum work environment.

- a. Be sure to ground the body when handling the LCD Modules.
- b. Tools required for assembly, such as soldering irons, must be properly ground.
- c. To reduce the amount of static electricity generated, do not conduct

assembly and other work under dry conditions.

- d. The LCD Module is coated with a film to protect the display surface. Be care when peeling off this protective film since static electricity may be generated.

10.2 Storage precautions

10.2.1 When storing the LCD modules, avoid exposure to direct sunlight or to the light of fluorescent lamps.

10.2.2 The LCD modules should be stored under the storage temperature range.

If the LCD modules will be stored for a long time, the recommend condition is:

Temperature : $0^{\circ}\text{C} \sim 40^{\circ}\text{C}$

Relatively humidity: $\leq 80\%$

10.2.3 The LCD modules should be stored in the room without acid, alkali and harmful gas.

10.3 The LCD modules should be no falling and violent shocking during transportation, and also should avoid excessive press, water, damp and sunshine.